

# V-SERIES

OIL LUBRICATED  
ROTARY VANE

---



+INTRODUCING THE **NEW V-VCS**

V-VGD

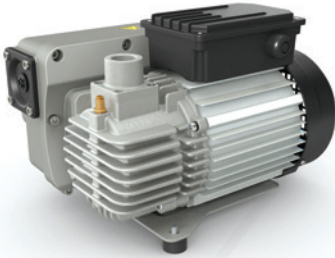

V-VCB

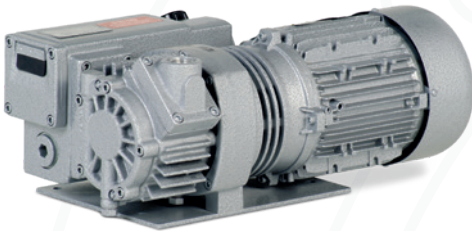

V-VCA / V-VCE

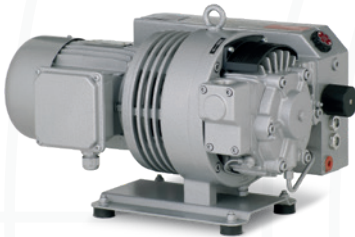

V-VC



INTRODUCING  
THE NEW V-VCS



# VACUUM PUMPS

## OUR OIL LUBRICATED ROTARY VANE RANGE

### V-VGD, V-VCB, V-VCA, V-VCE, V-VC AND V-VCS

Our oil lubricated rotary vane vacuum pumps are used in a wide variety of industrial applications. These are some of the advantages:



LONG VANE LIFE



LOW NOISE LEVEL



EASY TO SERVICE



HIGH WATER  
VAPOUR TOLERANCE



LONG SERVICE INTERVALS



FOR MANY INDUSTRIAL  
APPLICATIONS



OXYGEN CONVEYING  
PUMPS AVAILABLE



XD-VERSIONS WITH INCREASED VAPOUR  
TOLERANCE AND HIGH RESISTANCE TO  
SOLVENTS ALSO AVAILABLE



# WORKPLACE **APPLICATIONS**

ADAPTABLE TO A  
WIDE VARIETY OF  
INDUSTRIES AND  
APPLICATIONS

## **ENVIRONMENTAL ENGINEERING**

- Aeration
- Drying
- Dust extraction systems

## **FOOD PROCESSING**

- Bottling and filling machines
- Cutting machines
- Vacuum packing machines

## **INDUSTRIAL APPLICATIONS**

- Drying systems
- Dust extraction systems
- Industrial furnaces
- Vacuum hold down

## **PACKAGING INDUSTRY**

- Centralized vacuum systems
- Packaging machines

## **PNEUMATIC CONVEYING**

## **WOODWORKING INDUSTRY**

- Dust extraction systems
- Vacuum hold down

VACUUM & PRESSURE

# PRODUCT OVERVIEW

## V-VGD

Oil flooded rotary vane vacuum pump with capacities from 10 to 24 m<sup>3</sup>/h. The ultimate vacuum 2 mbar (abs.). Needs little space thanks to overhung rotor design and integral motor. Fitted as standard with fine mesh filter, vacuum non-return valve and oil separator. Very quiet running.

## V-VCB

Oil flooded rotary vane vacuum pump with capacities ranging from 20 to 26.5 m<sup>3</sup>/h, and an ultimate vacuum of 2 mbar (abs.). Designed especially for installation into small vacuum packaging machines. Flange mounted motor, bearings on both sides of the rotor, air cooling. Fitted with fine mesh filter, vacuum non-return valve and oil separator.

## V-VCA / V-VCE

Oil flooded rotary vane vacuum pumps with capacities ranging from 25 to 30 m<sup>3</sup>/h. Ultimate vacuum V-VCA at 0.5 mbar (abs.) and V-VCE at 10 mbar (abs.). Flange mounted motor, bearings on both sides of the rotor, air cooling. Fitted as standard with fine mesh filter, vacuum non-return valve, gas ballast valve and oil separator.

## V-VC

Oil flooded rotary vane vacuum pump with capacities ranging from 40 to 1,535 m<sup>3</sup>/h and an ultimate vacuum of 0.1 mbar (abs.). Flange mounted motor, bearings on both sides of the rotor, oil/air heat exchanger. All models include Aluminium alloy vanes, back pressure gauge, gas ballast valve(s), non-return valve and easy-access replaceable oil separators. Sizes of 400 m<sup>3</sup>/h and above include 5 micron paper inlet filter(s) and double-walled cylinder construction.



Enjoy three years of free carefree vacuum with our three year extended warranty plan available on VC and VCS pumps, (VC40 to VC1300).

This service is free of charge and all that is required is; 1. Have your installation approved by an authorized Elmo Rietschle representative or certified distributor. 2. Register for the Care3 Warranty Program. 3. Allow the authorised Elmo Rietschle service provider to deliver the recommended service schedule and validate your log book. 4. For you to use genuine Elmo Rietschle parts and lubricants for servicing.

## FEATURES & BENEFITS:

- FREE OF CHARGE
- SIMPLE TO JOIN
- 3 YEARS EXTENDED WARRANTY COVER
- GENUINE PARTS: SAVING THROUGH SUSTAINABLE OVERALL ENERGY EFFICIENCY
- PLANNED PROACTIVE AND PREVENTATIVE MAINTENANCE
- OPTIMISE ENERGY EFFICIENCY
- MINIMISES UNPLANNED DOWNTIME
- MAXIMISES UPTIME
- GIVES YOU ACCESS TO FACTORY TRAINED TECHNICIANS
- PROTECTS YOUR INVESTMENT

# INTRODUCING THE **NEW V-VCS**

## V-VCS - AN ENGINEERED EVOLUTION

The latest evolution in rotary vane design has arrived with the new VCS range in the Elmo Rietschle V-Series. The new V-VCS200 & V-VCS300 has been developed to improve the overall performance of this tried and tested rotary vane vacuum pump technology. This evolutionary design provides our lowest cost of ownership for an oil lubricated rotary vane vacuum pump, whilst weight, noise and size reductions make it easily adaptable and retrofittable to a wide range of OEM machines.



### ADVANTAGE AT A GLANCE

#### Our evolutionary new design offers:

- Lower lifetime costs with a reduction in filter requirements with no drop in oil particulate removal whilst consequently reducing maintenance requirements
- Reduced oil consumption also combines to make this machine one of our most eco-friendly oil lubricated machines available
- Design for the OEM market, the VCS model can be easily retrofitted into most machines

### TECHNICAL DATA

- Volume flow capacities ranging from 200 to 360 m<sup>3</sup>/hr
- Ultimate vacuum 0.5 mbar (abs)
- Noise emissions as low as 67 dB(A)
- Weight without motor 100kg
- IE3 and IE4 motor variants are available including 4kW, 5.5kW and 7.5kW as required
- Fitted as standard with flange motor
- Bearings on both sides of the rotor



**LESS HEAT**



**QUIETEST ON  
THE MARKET\***



**SMALLER SIZE  
& LIGHTER WEIGHT**



**IMPROVED ECO  
PERFORMANCE**



**CARE 3 EXTENDED  
WARRANTY**



# TECHNICAL SPECIFICATIONS

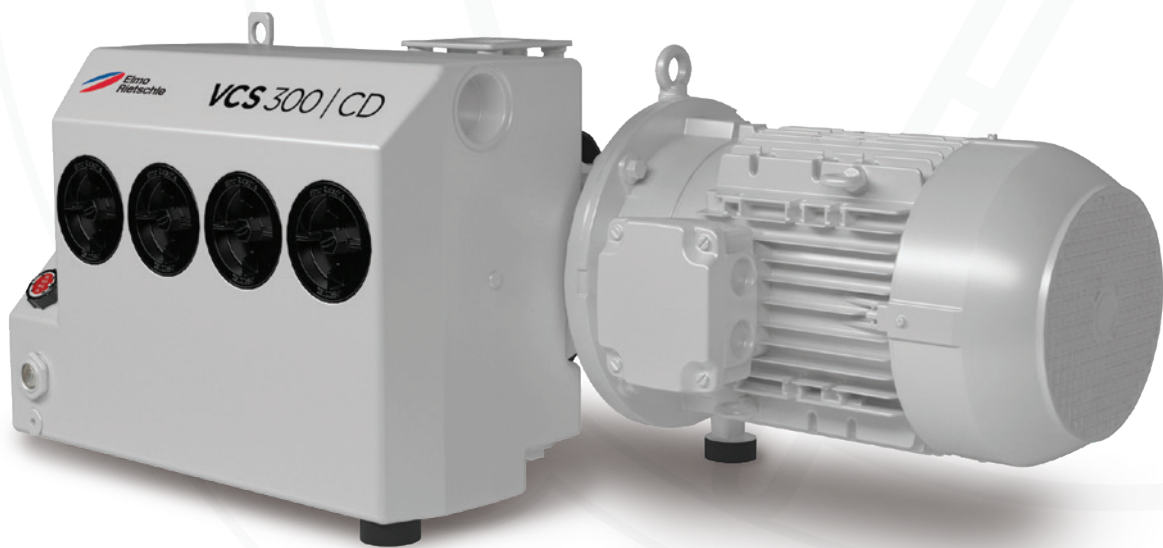
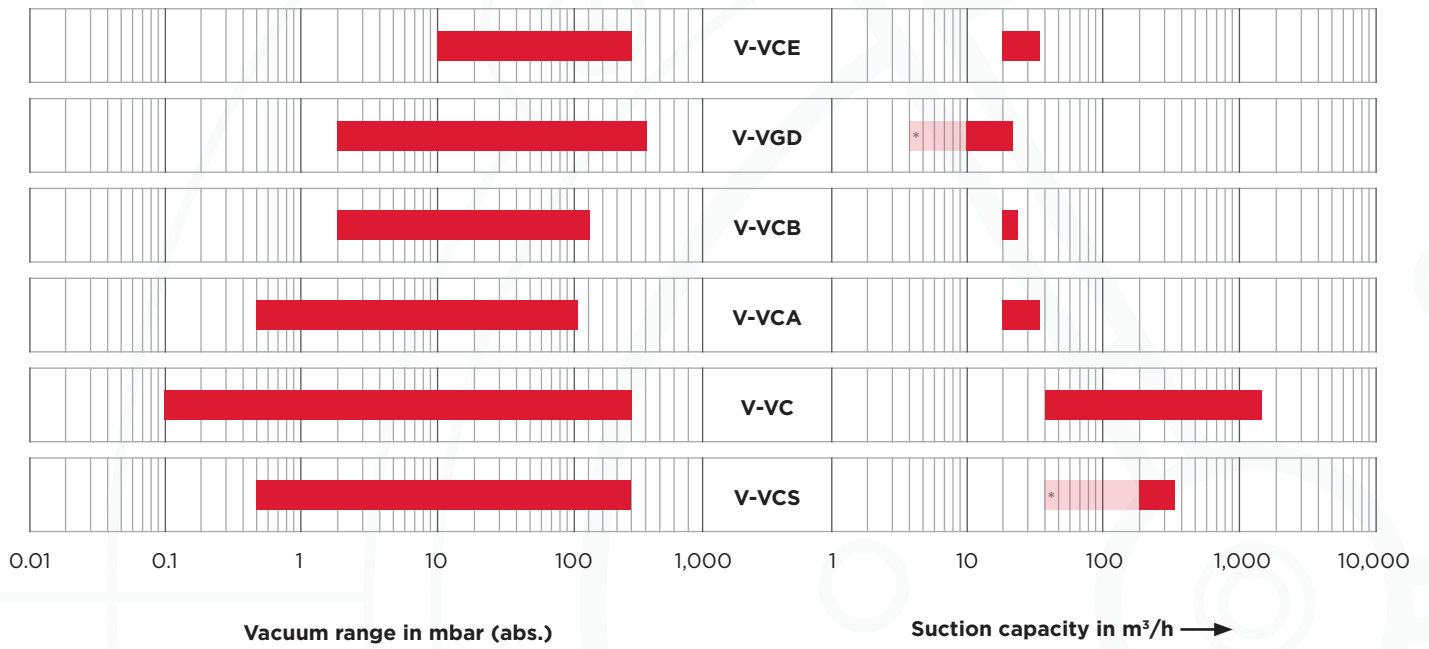

\*Future capability

## OPERATING PRINCIPLE

Pressure increase by volume reduction is the principle behind rotary vane operation. This design offers excellent service for pressure, vacuum or a combination of both.

In a cylindrical housing (1) a rotor (2) is positioned eccentrically so that it is on the top almost touching the cylinder (3). Rotor blades (5) are positioned inside rotor slots (4). When the rotor starts turning, due to centrifugal force the blades are thrown out and slide against the internal surface of the cylinder.

In this way a cell (6) is formed between two blades with a volume that changes constantly during rotation. Air enters from the inlet port (7) into a cell until the rear blade reaches the far end of the inlet port (8). At this point the cell (6) has achieved its maximum air volume.

As the cell then moves away from the port its volume (9) becomes smaller and smaller, the air is thus compressed and the pressure rises.

Some models are fitted with outlet valves (11) next to the outlet port (10) which stop the backflow of discharged air when the maximum pressure has been reached.

### DE-OILING ONCE THROUGH VACUUM PUMPS

After its passage through outlet port (10) and outlet valves (11), the oil-gas mixture reaches the de-oiling chamber (12) where the oil is separated from the gas in two steps. Larger oil drops are mechanically separated from the gas and are eventually deposited in the oil sludge recipient (13).

The remaining oil gas mixture is then taken through fine filter elements (14) which separate even the smallest oil particles. These are then reintroduced through an oil suction pipe into the pump's oil circuit. The virtually oil free gas can be let outside either through the air outlet (15) or through other hose or piping arrangements.

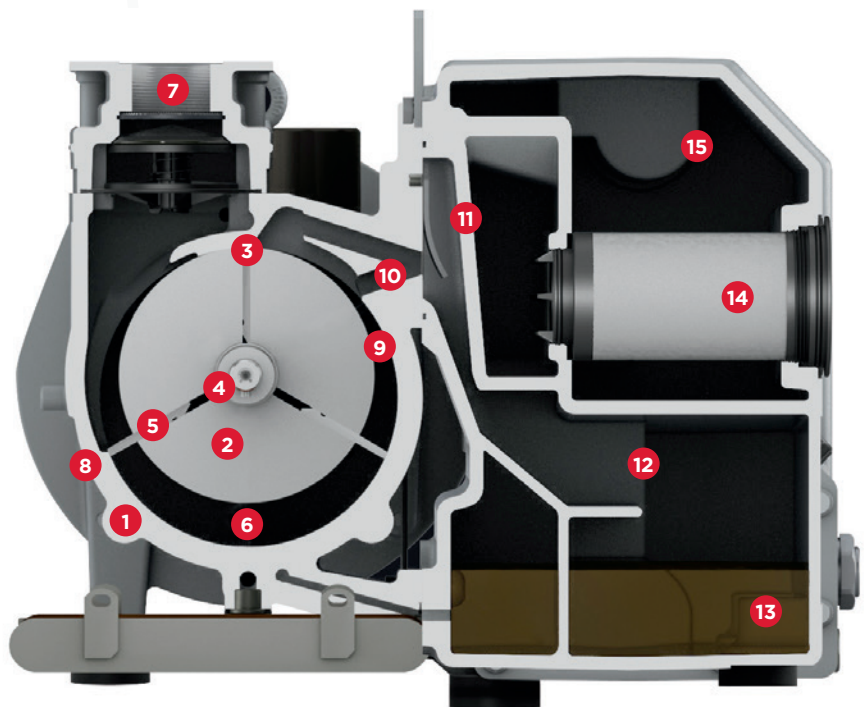



We have locations throughout the world to better supply and support you. Our expert local service personnel speak your language.

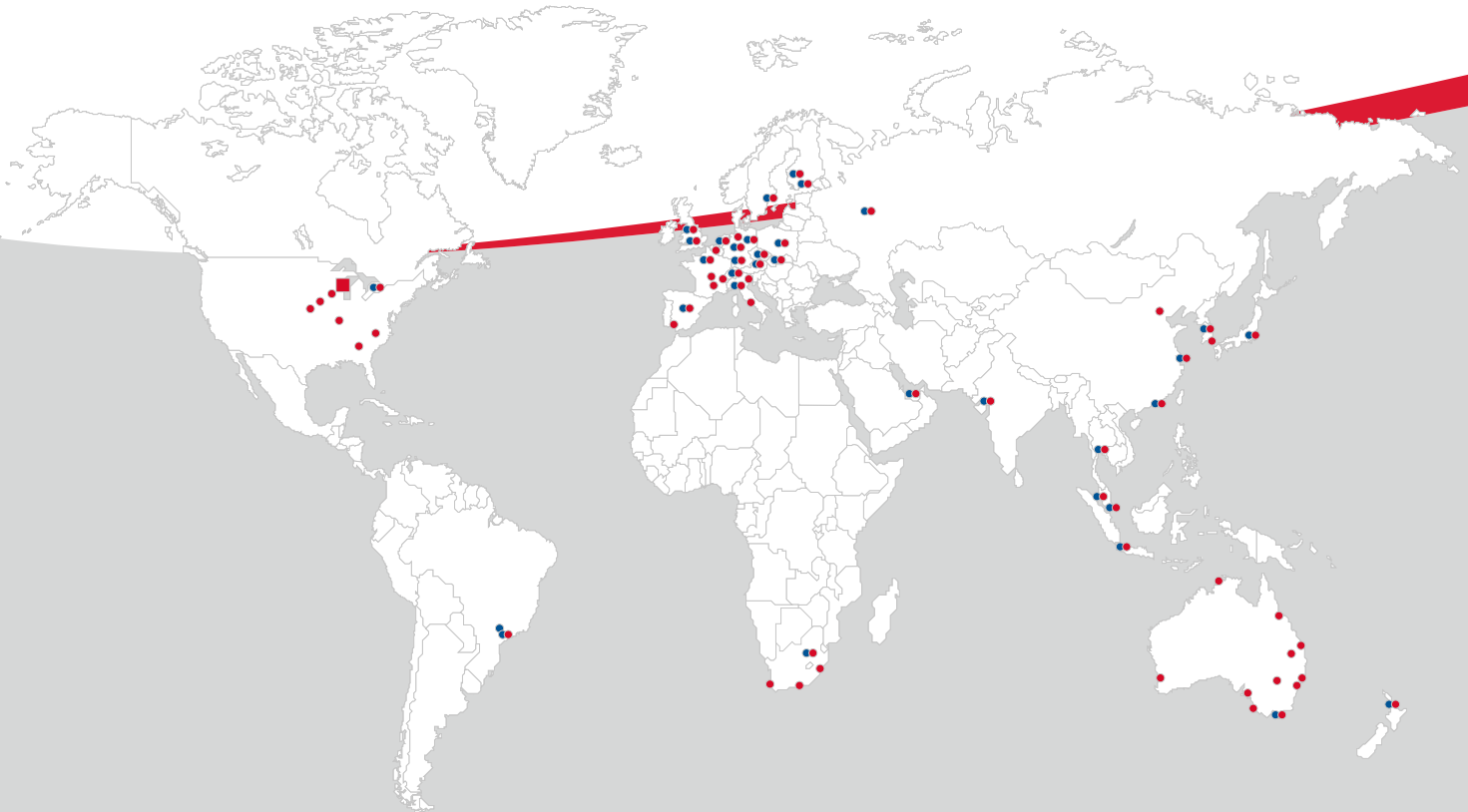

- CORPORATE HEADQUARTERS
- SALES/SERVICE LOCATIONS
- MANUFACTURING LOCATIONS



ELMO RIETSCHLE  
LOW PRESSURE & VACUUM SOLUTIONS

[www.gardnerdenver.com/elmorietschle](http://www.gardnerdenver.com/elmorietschle)

MISSION CRITICAL  
INDUSTRIAL AIR  
SOLUTIONS



**F-Series**  
Radial



**G-Series**  
Side Channel



**L-Series**  
Liquid Ring



**V-Series**  
Rotary Vane



**R-Series**  
Rotary Lobe



**C-Series**  
Claw



**S-Series**  
Screw



**X-Series**  
Systems